

## 4. Blood Relation Tricks

The blood relationship formula are outlined in this post. It would be useful to read and know these formula to answer the blood relationship questions of UPSC, IBPS PO, IBPS Clerk, RBI, SBI, other bank exams & all Insurance exams.

- |  |  |
|--|--|
| • Father's side  | – Paternal                                 |
| • Mother's side  | – Maternal                                 |
| • Mother's or Father's Father                                  | – Grandfather (Maternal or Paternal)       |
| • Mother's or Father's Mother                                  | – Grandmother (Maternal or Paternal)       |
| • Mother's or Father's Brother                                 | – Uncle                                    |
| • Mother's or Father's Sister                                  | – Aunt                                     |
| • Mother's or Father's Son                                     | – Brother                                  |
| • Mother's or Father's Daughter                                | – Sister                                   |
| • Son's Wife   | – Daughter-in-law                          |
| • Daughter's Husband   | – Son-in-law                               |
| • Husband's or wife's Father                                   | – Father-in-law                            |
| • Husband's or wife's Mother                                   | – Mother-in-law                            |
| • Husband's or wife's Brother                                  | – Brother-in-law                           |
| • Husband's or wife's Sister                                   | – Sister-in-law                            |
| • Sister's Husband   | – Brother-in-law                           |
| • Brother's Wife   | – Sister-in-law                            |
| • Brother's or Sister's Son                                    | – Nephew                                   |
| • Brother's or Sister's Daughter                               | – Niece                                    |
| • Uncle's or Aunt's Son or Daughter<br><b>Cousin)</b>          | – Cousin <b>(He is considered as First</b> |
| • Son or Daughter of the First Cousin<br><b>Second Cousin)</b> | – Cousin <b>(He is mainly addressed as</b> |
| • Grandson's or Grand Daughter's Son                           | – Great Grand son                          |
| • Grandson's or Grand Daughters's Daughter                     | – Great Grand Daughter                     |
| • Father's or Mother's Aunt                                    | – Grand Aunt or Grand Aunt                 |
| • Father's or Mother's Uncle                                   | – Grand Uncle or Great Uncle               |
| • Real Brother or Sister <b>(Common Parents)</b>               | – Sibling                                  |

### How to Draw Tree Diagram

- For Male Use “+” Symbol and for Female use “-” Symbol.
- A is Father of B
- Here we know A is Male and we don't know about B.

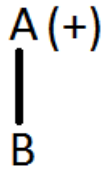

- 
- A is Mother of B

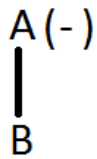

- 
- A is the Wife of B



- 
- (Use Heart symbol when it is about couples)

---

  - A and B are Brothers and C is their Mom and D is their Dad.

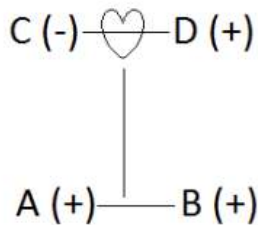

- 
- A and B are the Parents of C and D. E and F are sisters. C is their Mother. Z is husband of C.

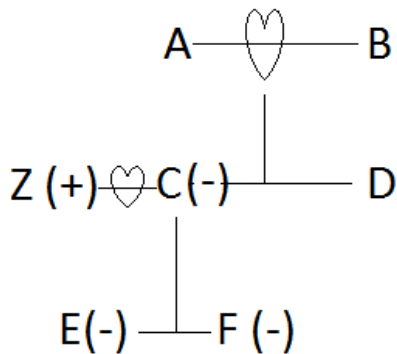

Z is the Son-in-law of A and B. We don't know the gender of D. The possibility for D is Uncle/Aunt of E and F. If D is Male it makes him Brother-in-law of Z and if D is Female it makes her Sister-in-law of Z.

- This is the basic in solving Problems related to Blood Relationship. You need to accurate and also fast. In this area it is possible to save lots of time. Do solve more problems and understand how the TREE works. You don't need to follow exactly the above steps. If you are comfortable in some other way follow that.
- If A is the brother of B; B is the sister of C; and C is the father of D, how D is related to A?

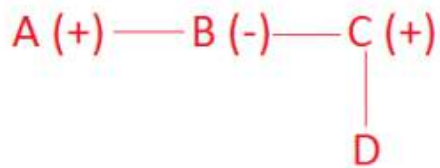

- We don't know the Gender of D. The Possibilities are,
  - If D is Male – Nephew.
  - If D is Female – Niece.
- P is the mother of K; K is the sister of D; D is the father of J. How is P related to J?

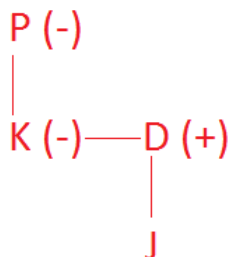

- P is Grandmother of J.

- A's son B is married with C whose sister D is married to E the brother of B. How D is related to A?

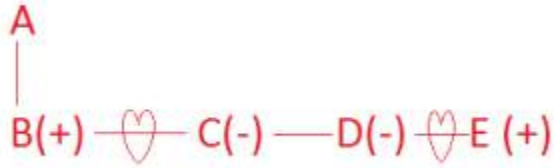

- From the Diagram, it is clear that, B and E are Brothers; C and D are Sisters. B and E are Sons of A.
- The Answer – D is the Daughter-in-law of A.
- T is the Sister of R, who is the Brother of V, who is the Son of S. How T related to S?

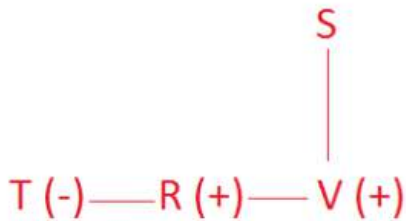

- T is the Daughter of S.
- T is the Brother of R, who is the Mother of V, who is the Brother of S. How S related to T?

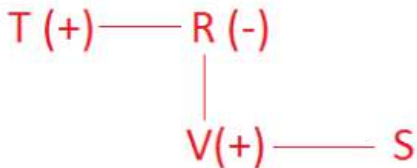

- We don't the Gender of S. But the Possibility is S is the Nephew/Niece of T
- P is the Son of Q, who is the Brother of R, who is the Daughter of T. How is P related to T?

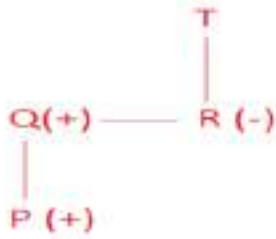

- P is the Grandson of T.
- A is the only Son of B, who is the Father of C. How C related to A?

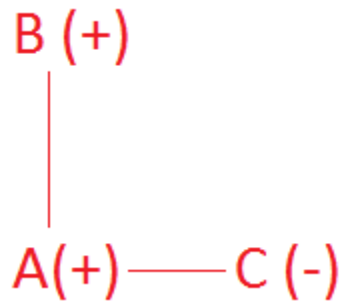

The “**Only Son**” word makes C Female. So C is the Sister of A.

**Q1. Pinky, who is Victor's daughter, say to Lucy, "Your Mother Rosy is the younger sister of my Father, who is the third child of Joseph." How is Joseph related to Lucy?**

- Father - In - Law
- Father
- Maternal Uncle
- Grand Father

**Solution**  
(Option D)

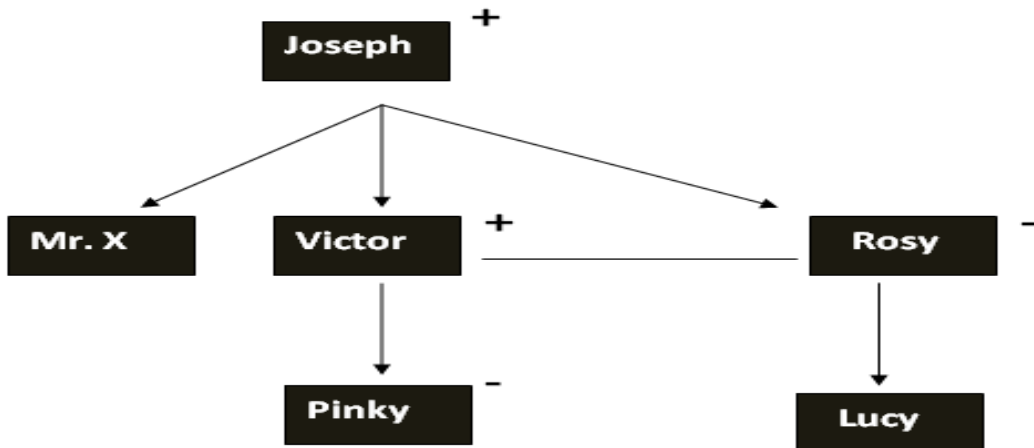

Joseph has three children, One is X, second is Victor and Third is Rosy. It is not clear X is male or female. Rosy is the mother of Lucy so Joseph is the grandfather of Lucy that is clearly shown in the above diagram.

**Q2. Mohan is the Son of Arun's Father's sister. Prakash is the son of Reva, who is the mother of Vikas and Grandmother of Arun. Pranab is the father of Neela and the grandfather of Mohan. Reva is the wife of Pranab. How is the wife of Vikas related to the Neela?**

- a) Sister
- b) Sister - In - Law
- c) Niece
- d) None of The Above

**Solution**  
**(Option B)**

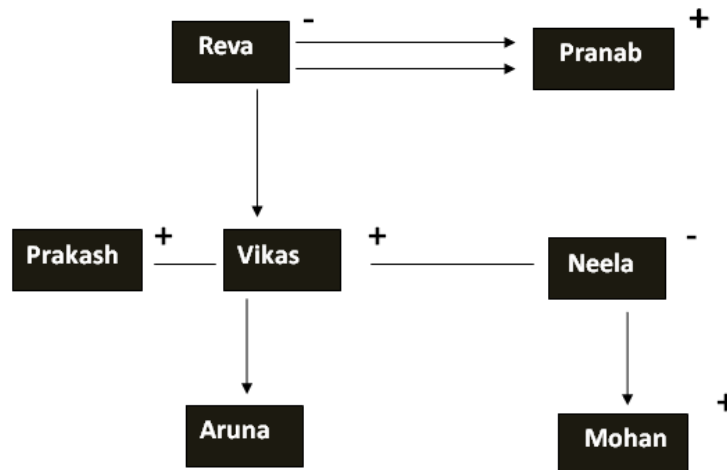

As the diagram shows that Vikas is Neela's brother so wife of Vikas will be Neela's Sister - in - Law.

**Q3. T, S and R are three brothers. T's son Q is married to K and they have one child Rahul blessed to them. M the son of S is married to H and this couple is blessed with a daughter Madhvi. R has a daughter N who is married to P. This couple has one daughter Karuna born to them. How is Madhvi related to S?**

- a) Daughter
- b) Niece
- c) Grand Daughter
- d) None of The Above

**Solution**  
**(Option C)**

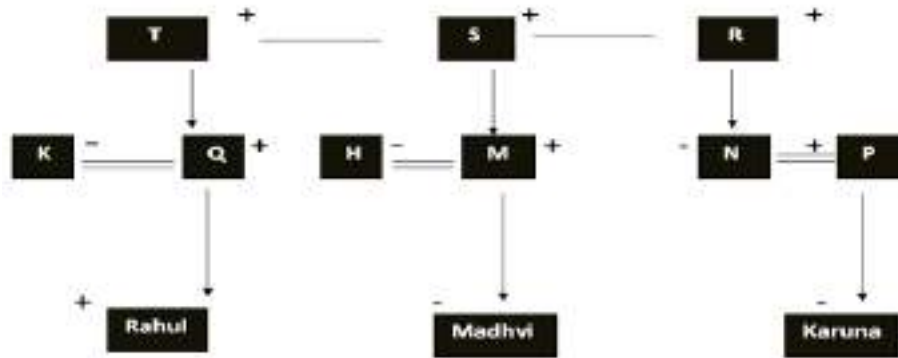

In the above diagram, it clearly shows that Madhvi is granddaughter of S.

**Q4. Arti and Sourabh are the children of Mr and Mrs Shah. Ritu and Shakti are the children of Mr and Mrs. Mehra. Sourabh and Ritu are married to each other and two daughter Mukti and Shruti are born to them. Shakti is married to Rina and two children Subhash and Reshma are born to them. How is Arti related to Shruti?**

- a) Mother
- b) Mother - in - Law
- c) Sister
- d) Aunt

**Solution**  
**(Option D)**

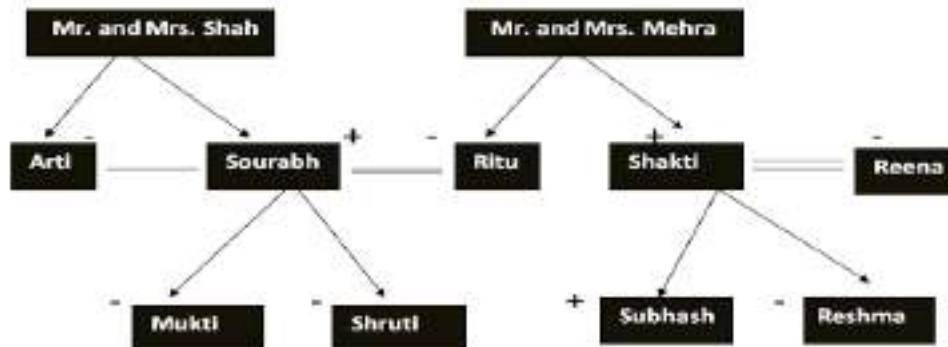

Arti is Aunt of Shruti. It can be seen clearly from the above diagram.

**Q5. In a family, there are seven persons, comprising two married couples. T is the son of M and the grandson of K. M is a widower. M and R are brothers and W is the daughter - in - Law of J, who is the mother of R and the grandmother of D. How is D related to M?**

- a) Son
- b) Son - in - Law
- c) Nephew or Niece
- d) Brother

**Solution**  
(Option C)

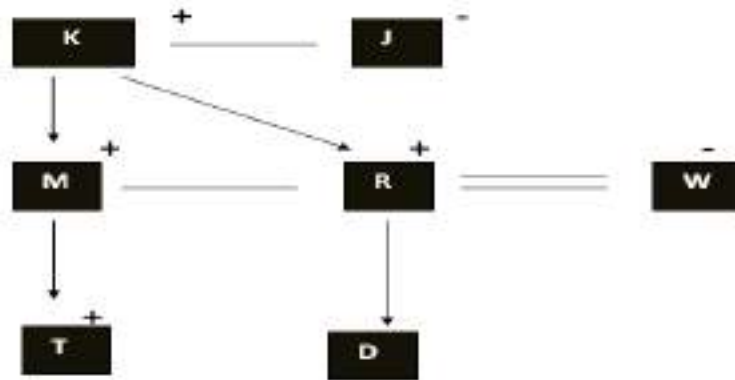

D is Nephew or Niece of M because gender of D is not specify in the question.

We have included Some questions that are repeatedly asked in bank exams !!!

**1. Direction:(1-3)**

**A – B means A is wife of B**

**A ÷ B means A is brother of B**

**A + B means A is daughter of B**

**A × B means A is son of B**

**How is A related to D in the given expression ?**

**A + B – C × D**

- 1)Grand son
- 2)Granddaughter
- 3)Daughter
- 4)Mother

**Answer2)Granddaughter**



2. Which of the following symbol will come in place of ? to make the expression Q is daughter-in-law of T true ?

$$P + Q - R ? S - T$$

- 1)×
- 2)+
- 3)-
- 4)÷

Answer1)×

3. In which of the following expressions N is the father of M ?

- 1) $M \times N \div O - P$
- 2) $N - O \times P \div M$
- 3) $P \div O \times M - N$
- 4)None

Answer1) $M \times N \div O - P$

4. Direction(4-5)

A @ B means A is wife of B

A \$ B means A is father of B

A # B means A is mother of B

A % B means A is son of B

A © B means A is sister of B

How is P related to M in the given expression:  $M \% N © O @ P \$ Q$  ?

- 1)Brother
- 2)Father
- 3)Aunt
- 4)Uncle

Answer4)Uncle

5. Which of the following expression represents D is brother of G ?

- 1) $D @ E \$ F \$ G$
- 2) $D \% E @ F \$ G$
- 3) $G \% F @ E \$ D$
- 4)None

Answer2) $D \% E @ F \$ G$

6. Direction(6-8)A is the sister of B. B is married to C. C is the son of D. A is the mother of E. F is the father of G. F has only 1 son and 1 daughter. G is the daughter of A. H is the son of B.

How is H related to D ?

- 1)Granddaughter
- 2)Daughter

- 3)Grandson
- 4)Son

**Answer3)Grandson**

7. **How is C related to A ?**

- 1)Brother
- 2)Sister
- 3)Uncle
- 4)Brother-in-law

**Answer4)Brother-in-law**

8. **How is E related to B ?**

- 1)Uncle
- 2)Son
- 3)Niece
- 4)Nephew

**Answer4)Nephew**

9. **P is brother of Q. R is sister of Q.S is father of R. How is Q related to S ?**

- 1)Son
- 2)Daughter
- 3)Daughter or Son
- 4)Sister

**Answer3)Daughter or Son**

10. **A persons pointing to a photograph says, 'This lady is my sister's son's grandmother'. How is the lady related to that person ?**

- 1)Mother
- 2)Father
- 3)Brother
- 4)Sister

**Answer1)Mother**